

0cm 5cm

A1

0 inch 3 inch

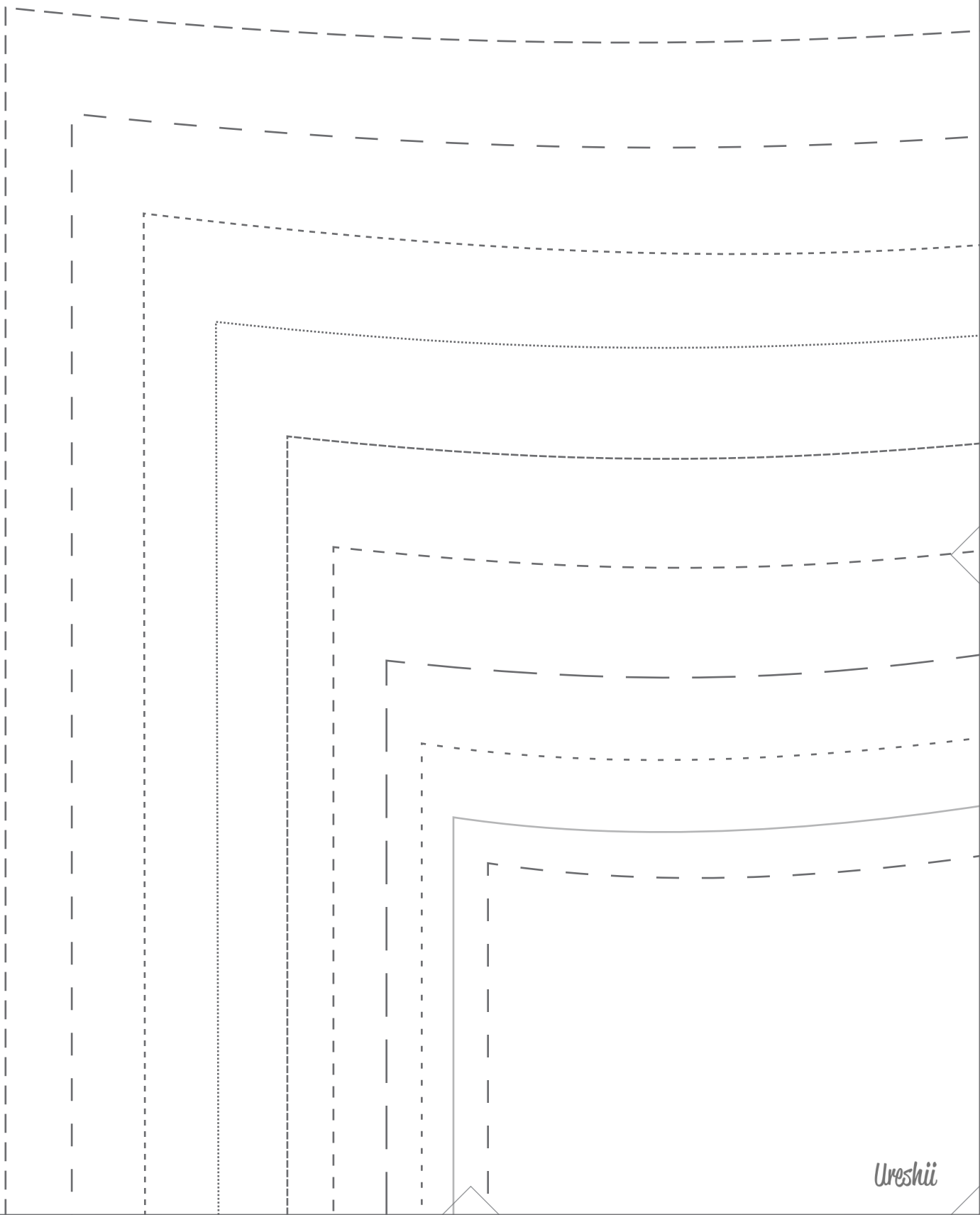

0cm 5cm

A2

0 inch 3 inch

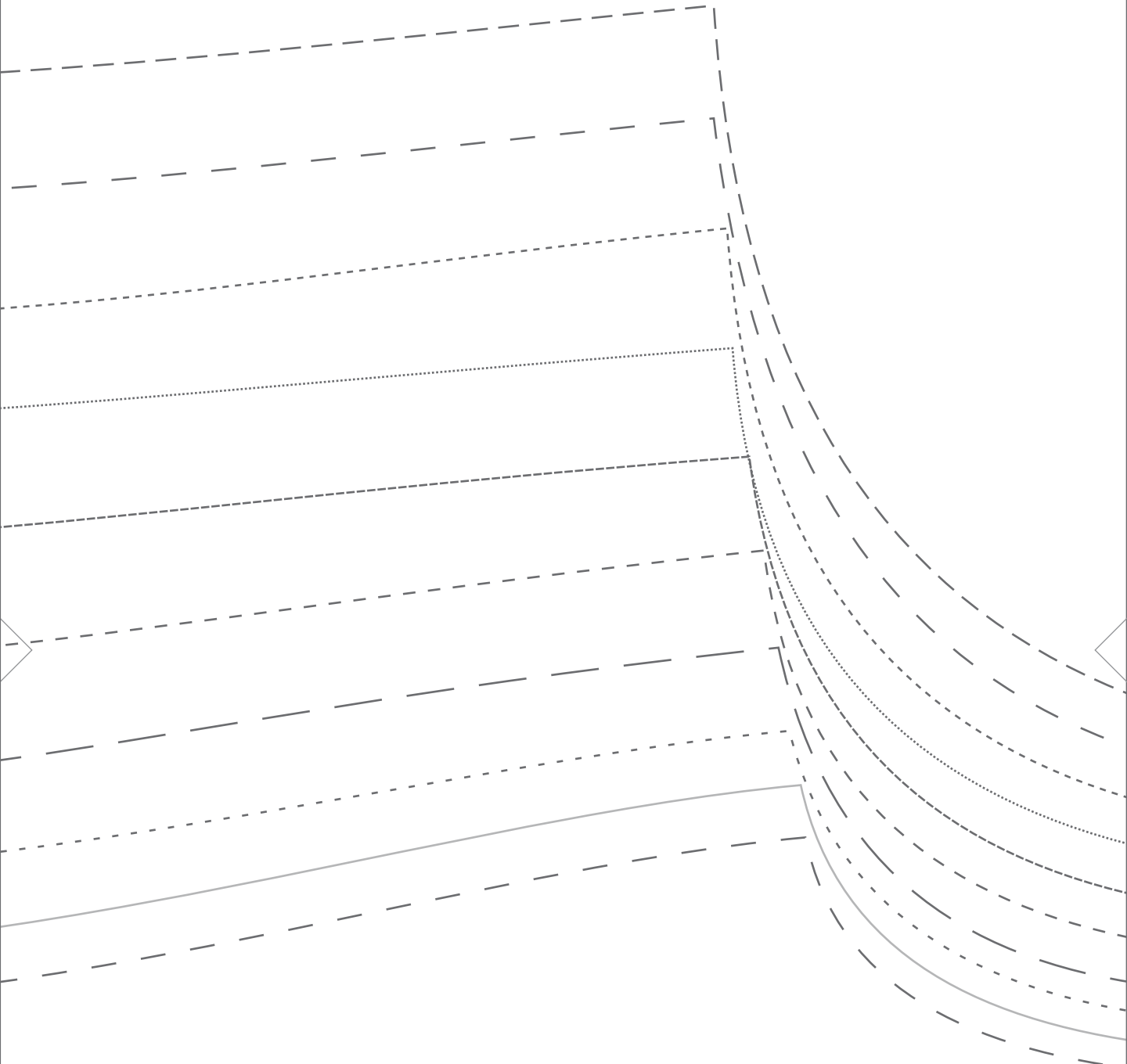

0cm 5cm

A3

0 inch 3 inch

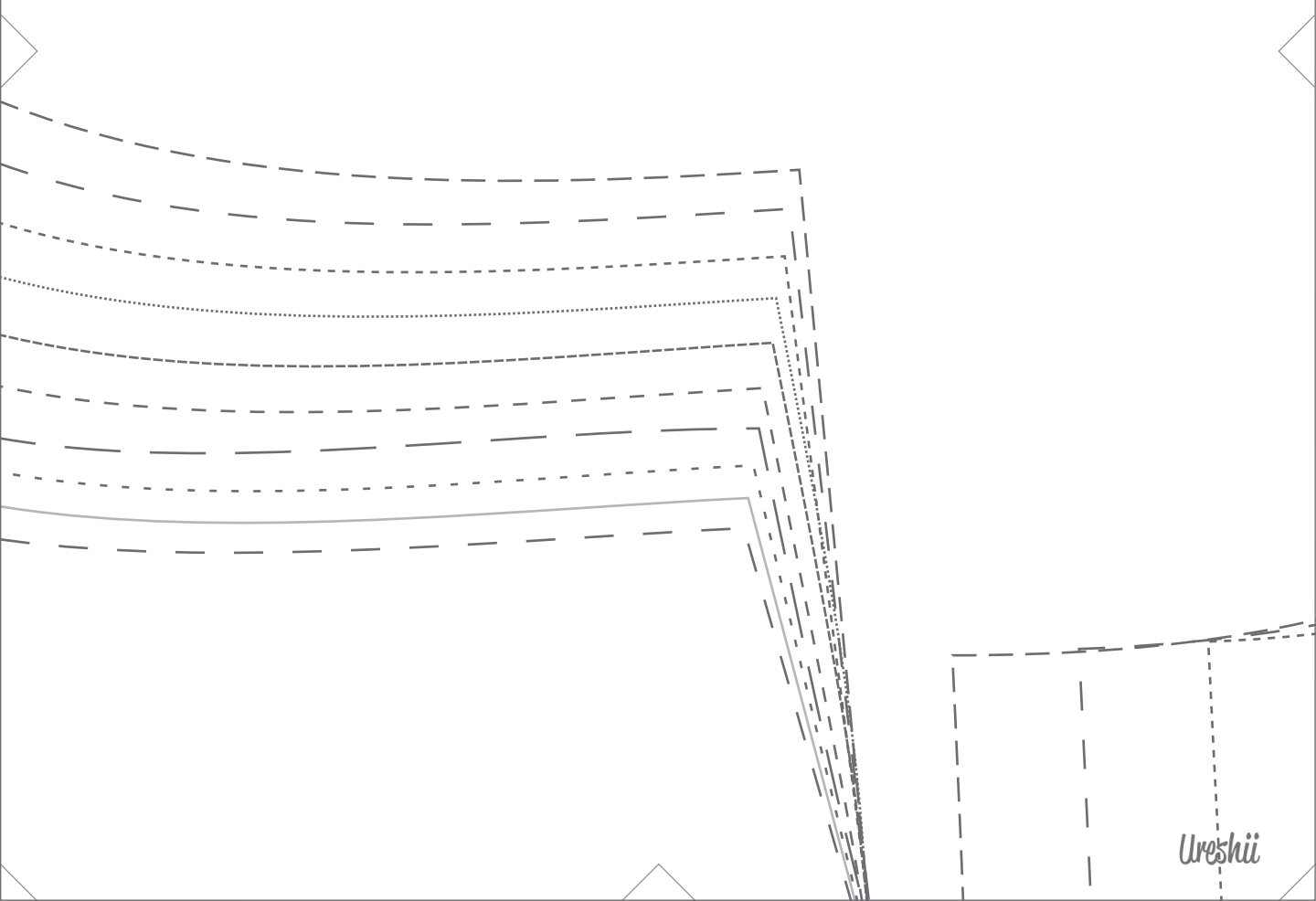

Ureshii

0cm 5cm

A4

0 inch 3 inch

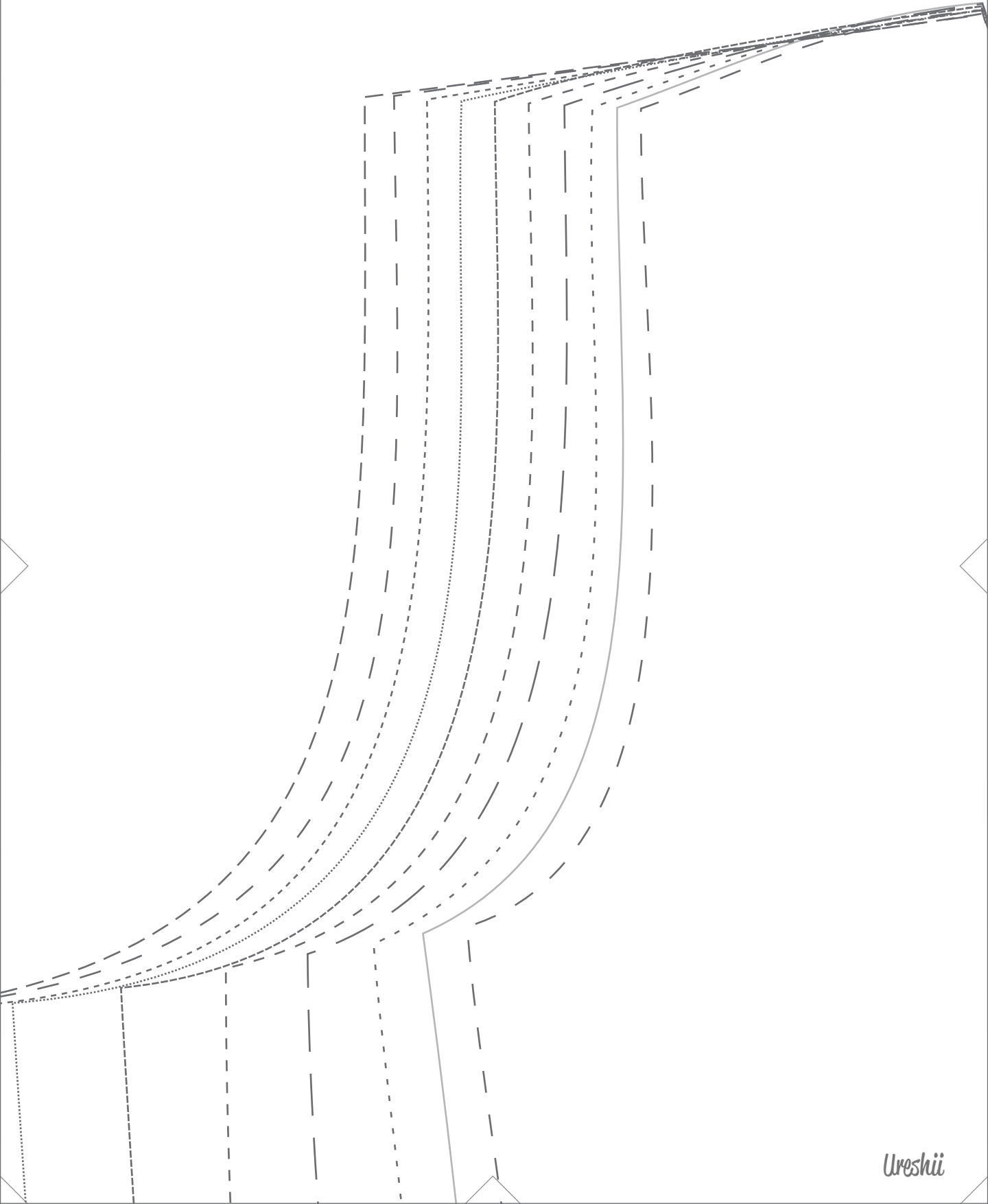

0cm 5cm

A5

0 inch 3 inch

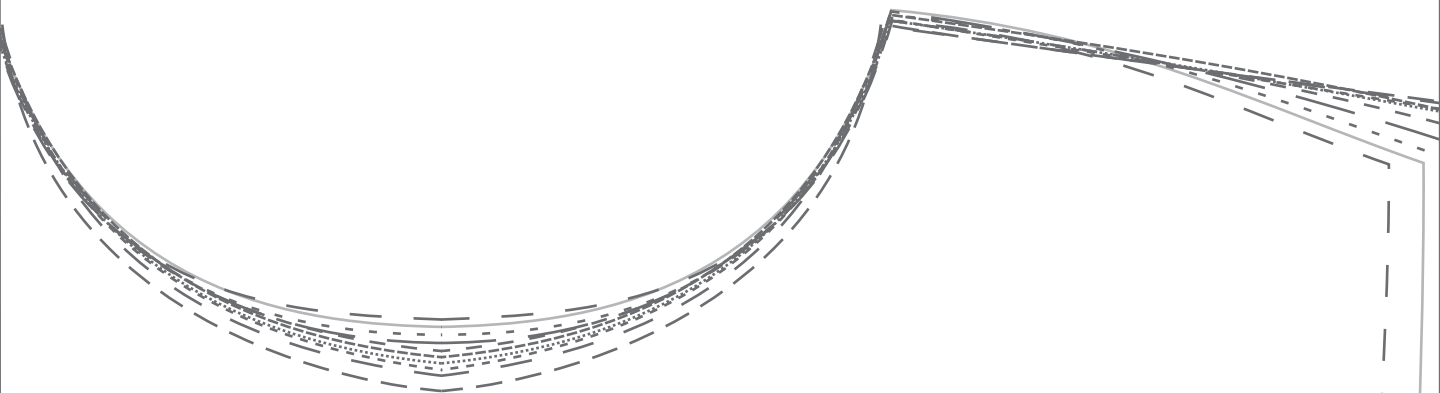

Binder Pattern

Back Overlay

Chest size: all sizes

Cut 1 in jersey fabric

more info @ <https://linktr.ee/freebinderpattern>
or <https://ureshiidesign.ca/blog/binder-free-sewing-pattern-download/>

Ureshii

0cm 5cm

A6

0 inch 3 inch

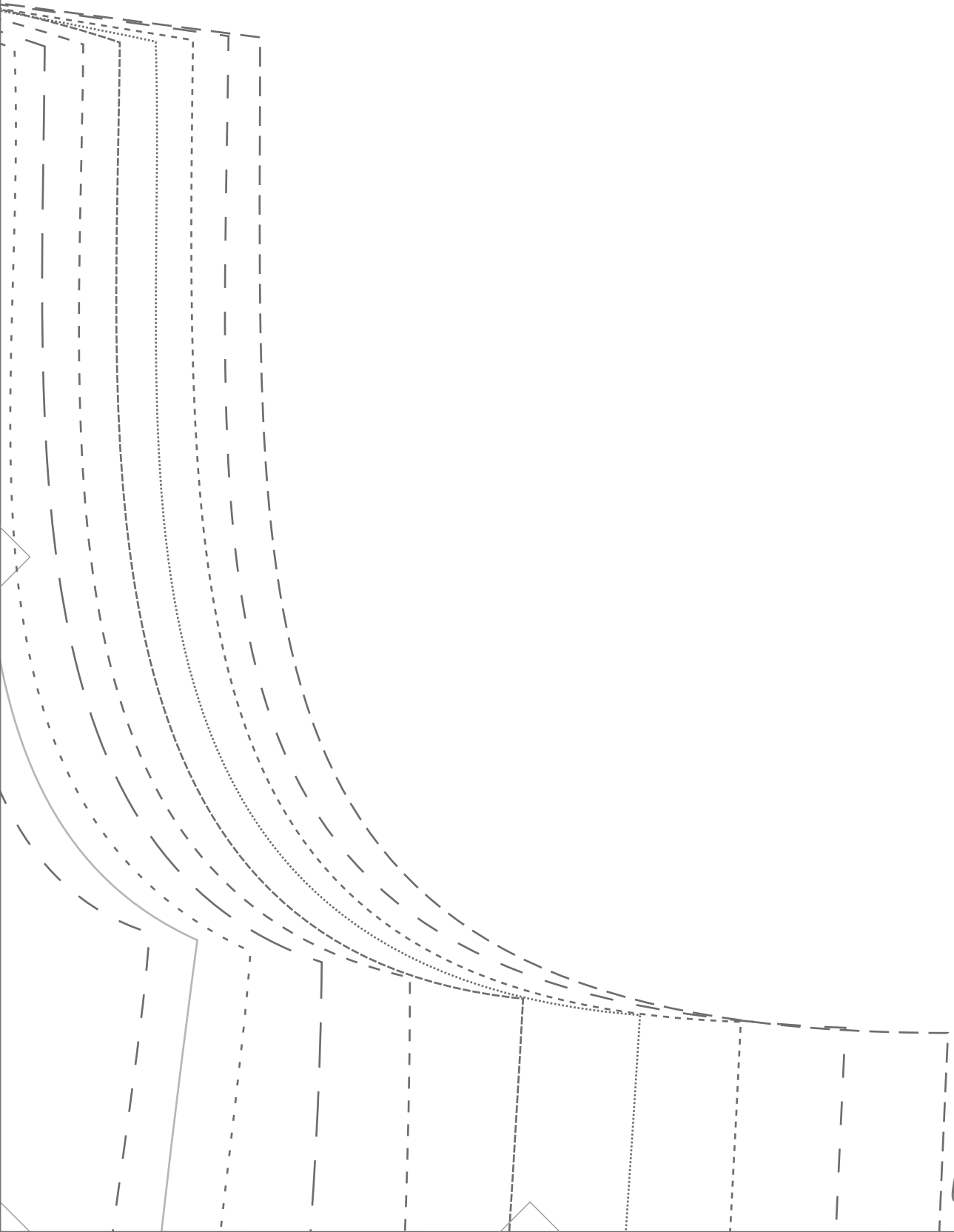

Ureshii

0cm

5cm

B1

0 inch

3 inch



Ureshii Design

<https://ureshiidesign.ca>

Direction of greatest stretch



0 inch

3 inch

0cm

5cm

B2

Binder Pattern

Front Underlay

Chest size: all sizes

Cut 1 in jersey fabric

Cut 1 in mesh fabric

more info @ <https://linktr.ee/freebinderpattern>

or <https://ureshidesign.ca/blog/binder-free-sewing-pattern-download/>



ureshii

0cm

5cm

B3

0 inch

3 inch

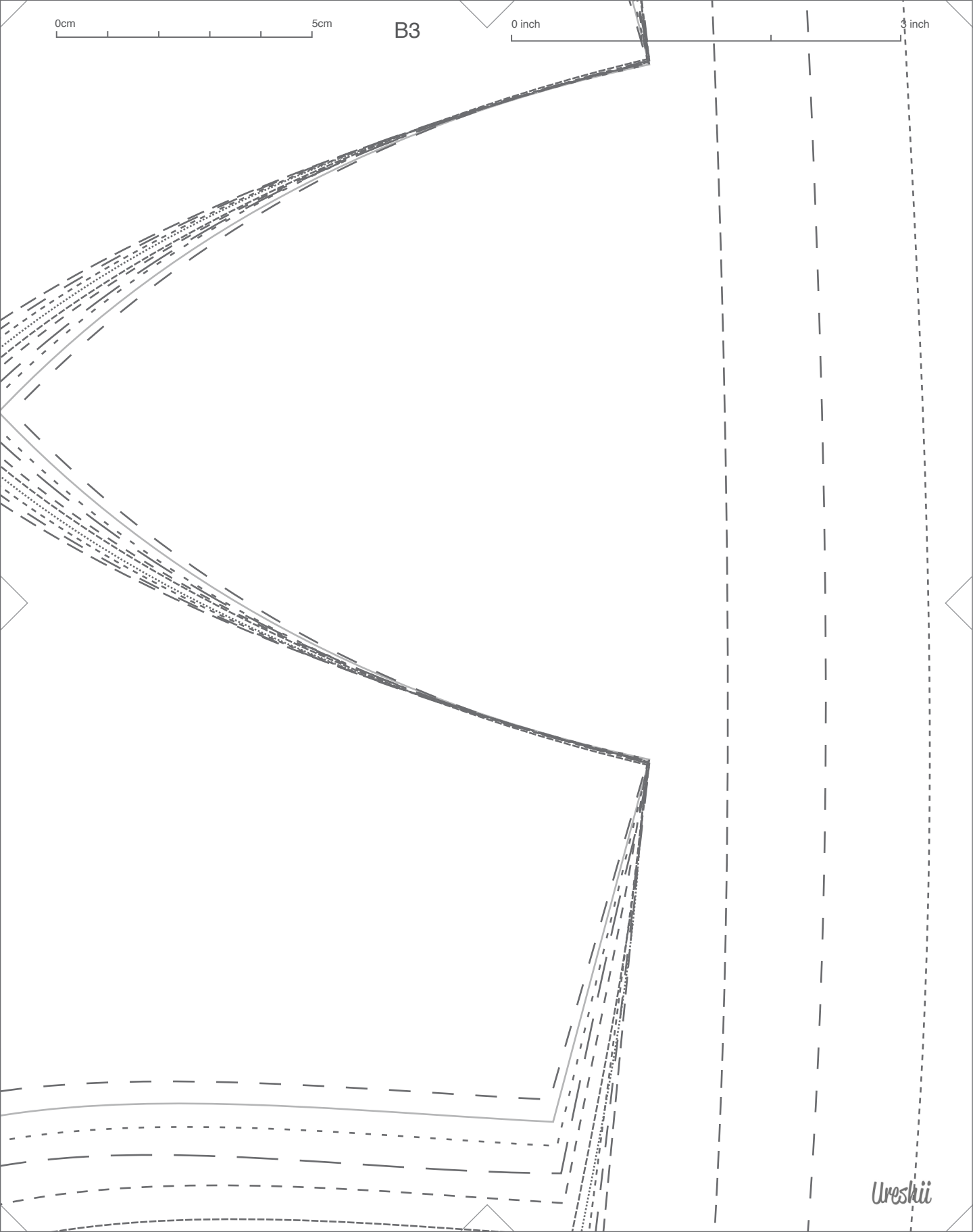

0cm

5cm

B4

0 inch

3 inch

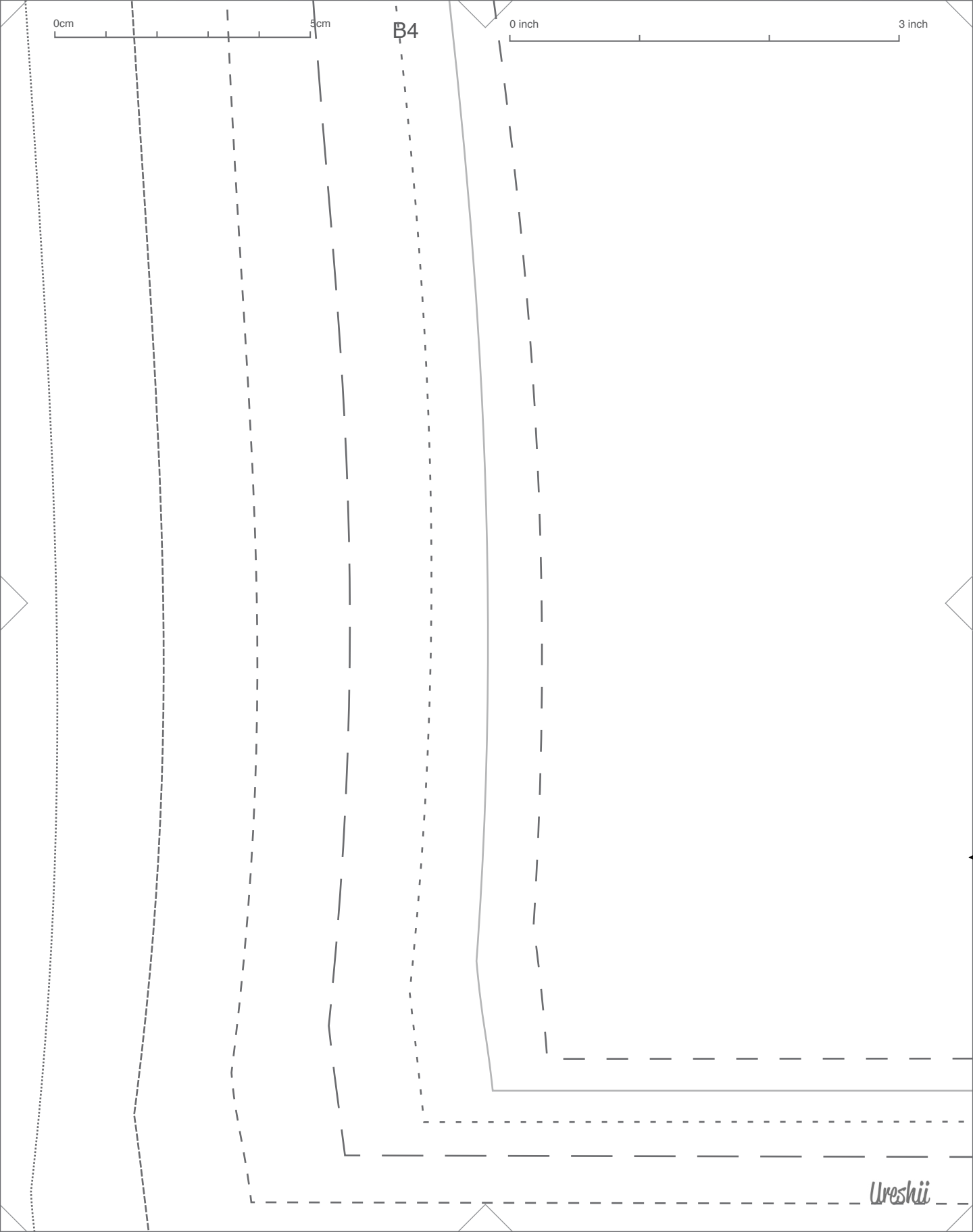



Ureshii Design
<https://ureshiidesign.ca>

Direction of greatest stretch

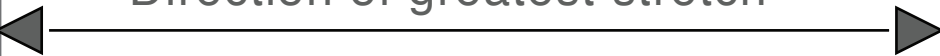

0cm

5cm

B6

0 inch

3 inch

0cm

5cm

C1

0 inch

3 inch

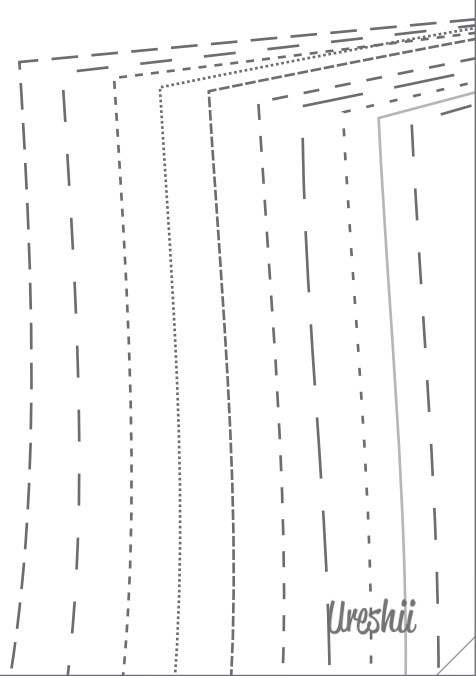
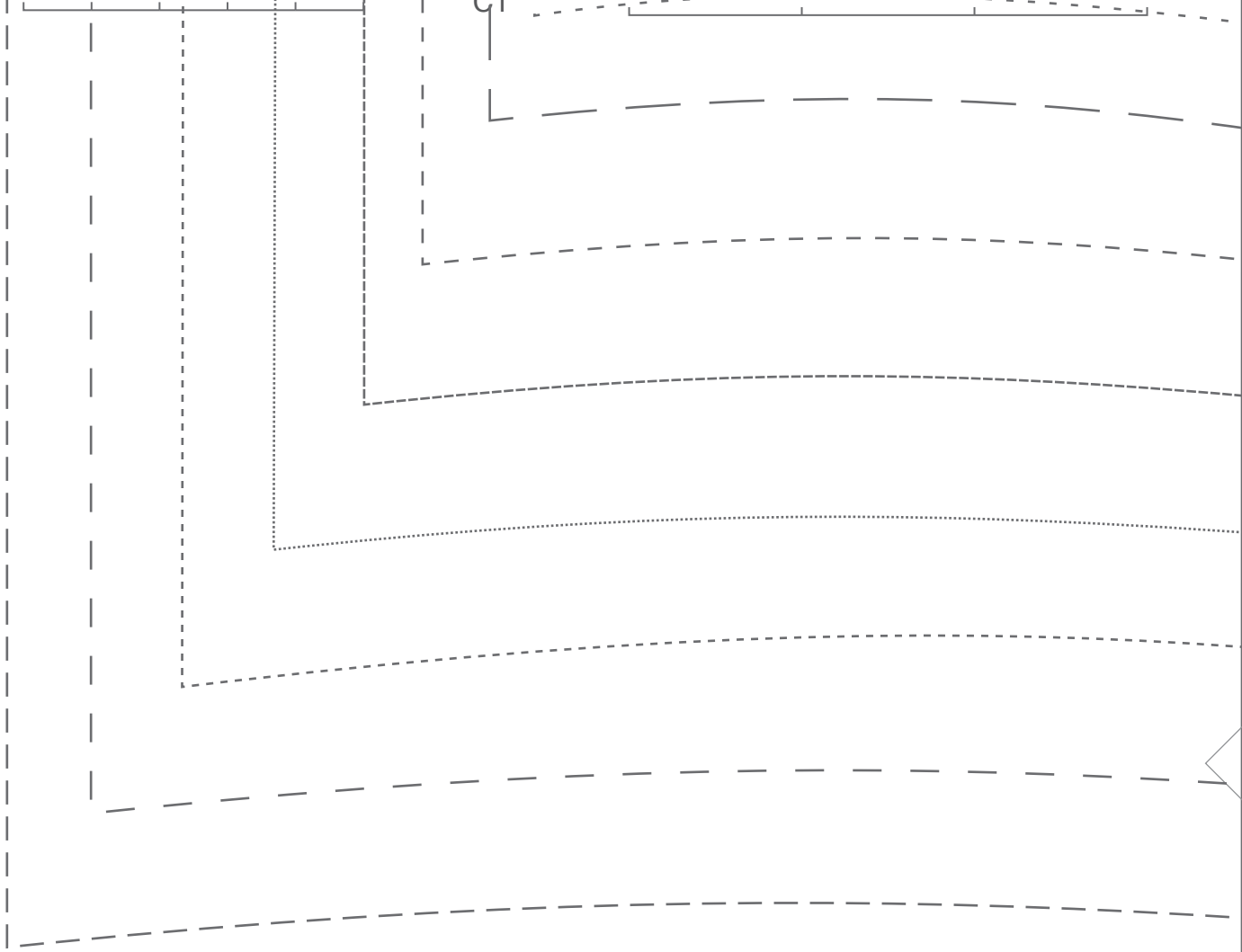

0cm

5cm

C2

0 inch

3 inch

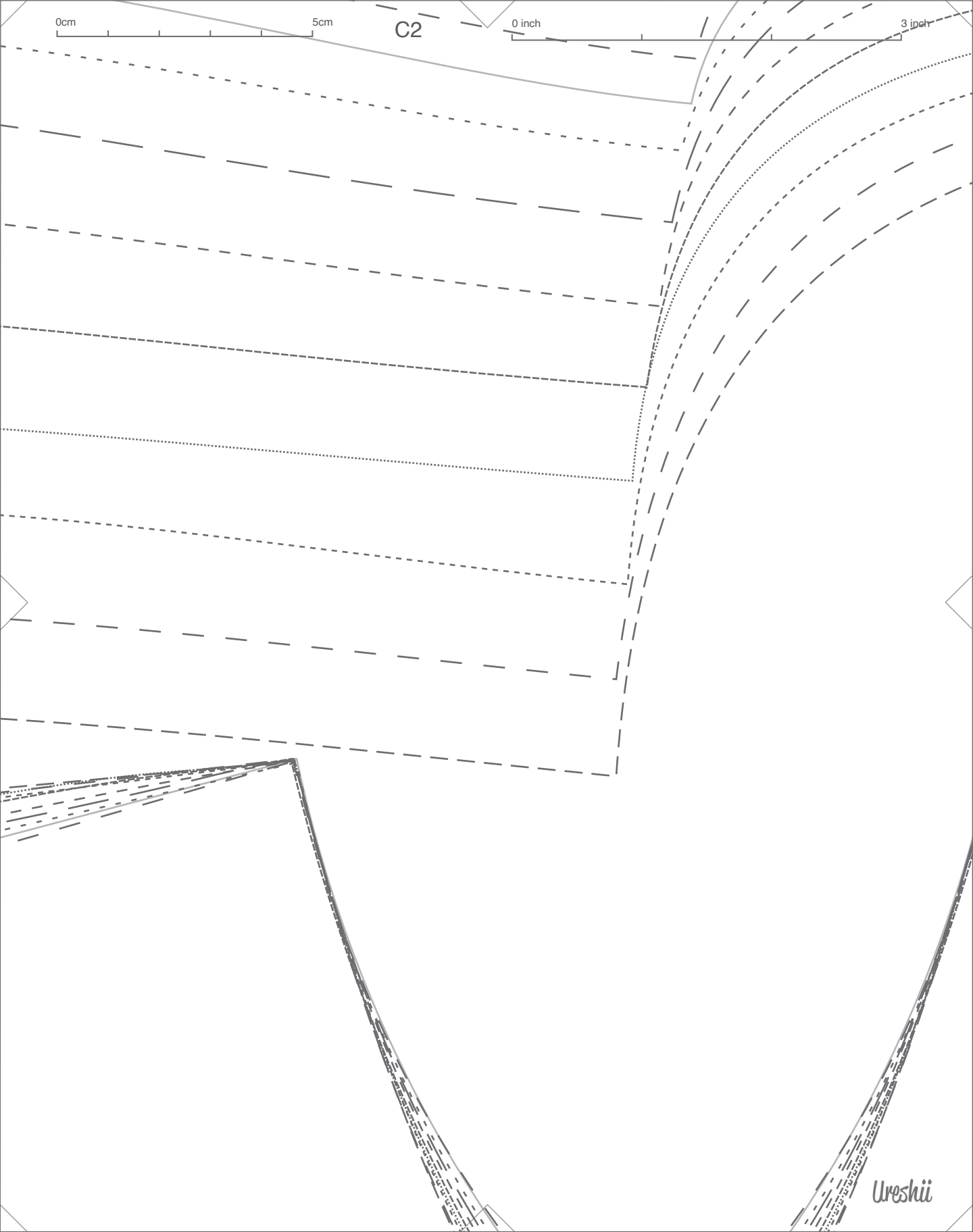

Ureshii

0cm

5cm

C3

0 inch

3 inch

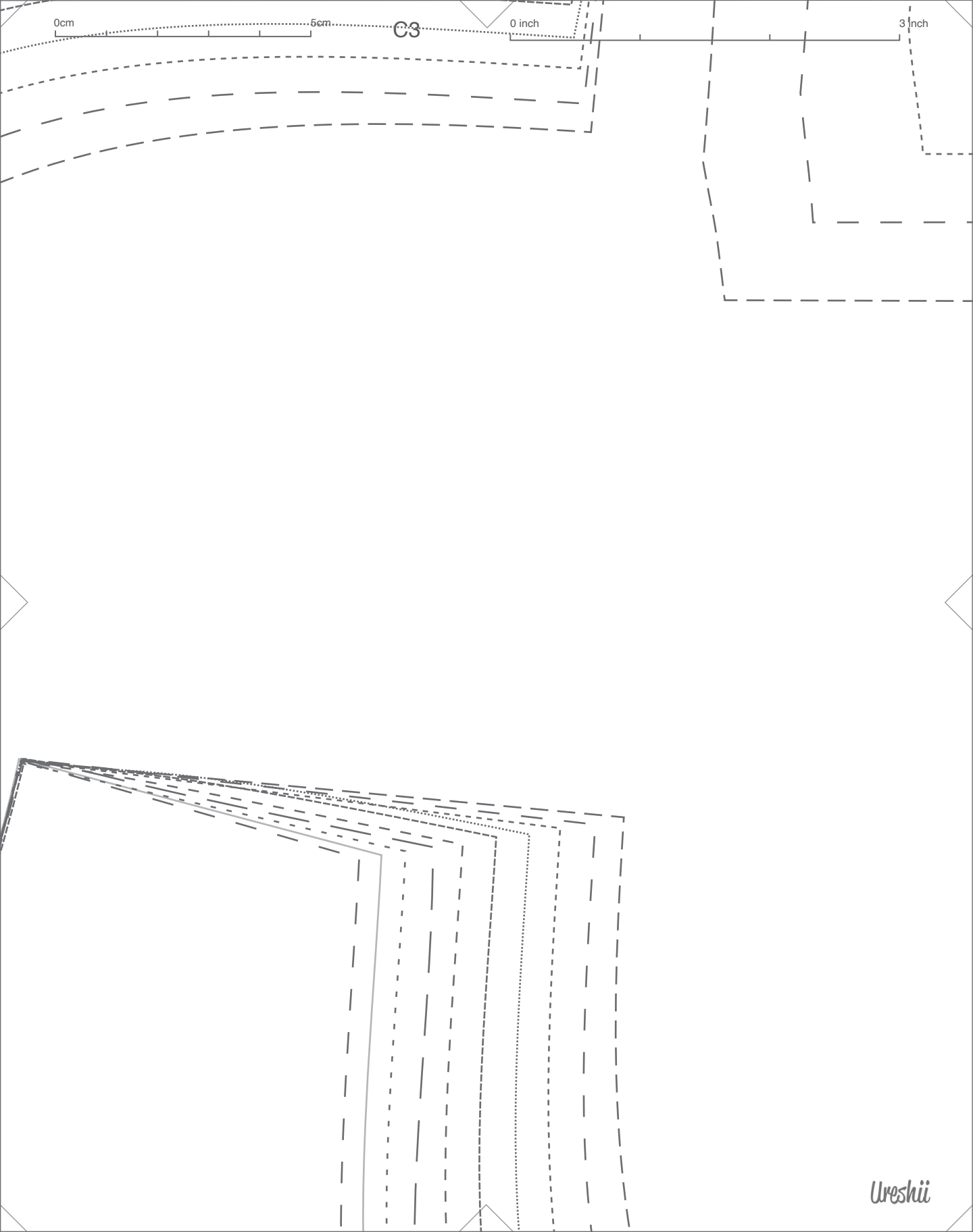

0cm

5cm

C4

0 inch

3 inch

Ureshii

0cm 5cm

C5

0 inch 3 inch

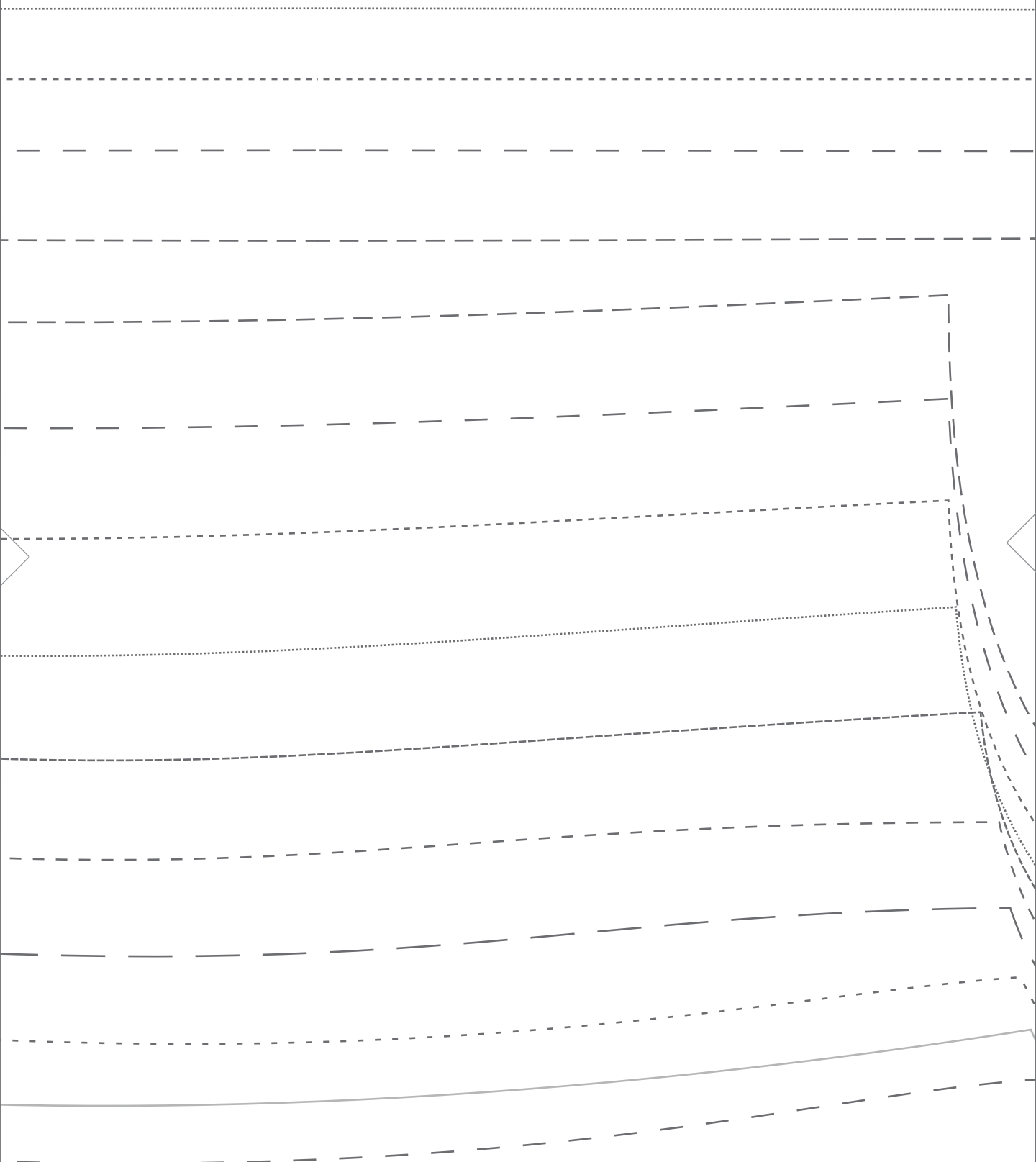

0cm

5cm

C6

0 inch

3 inch

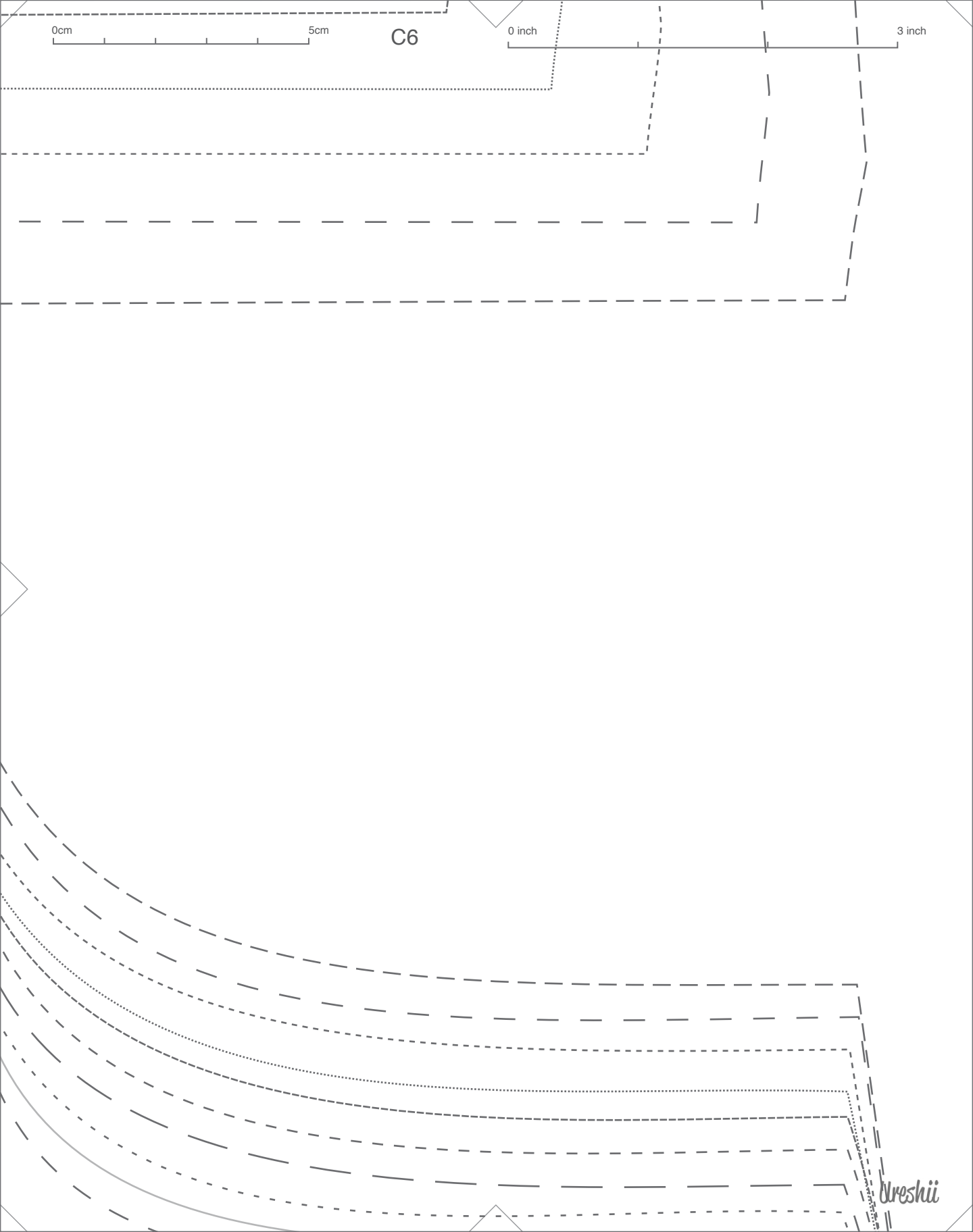

0cm 5cm

D1

0 inch 6 inch

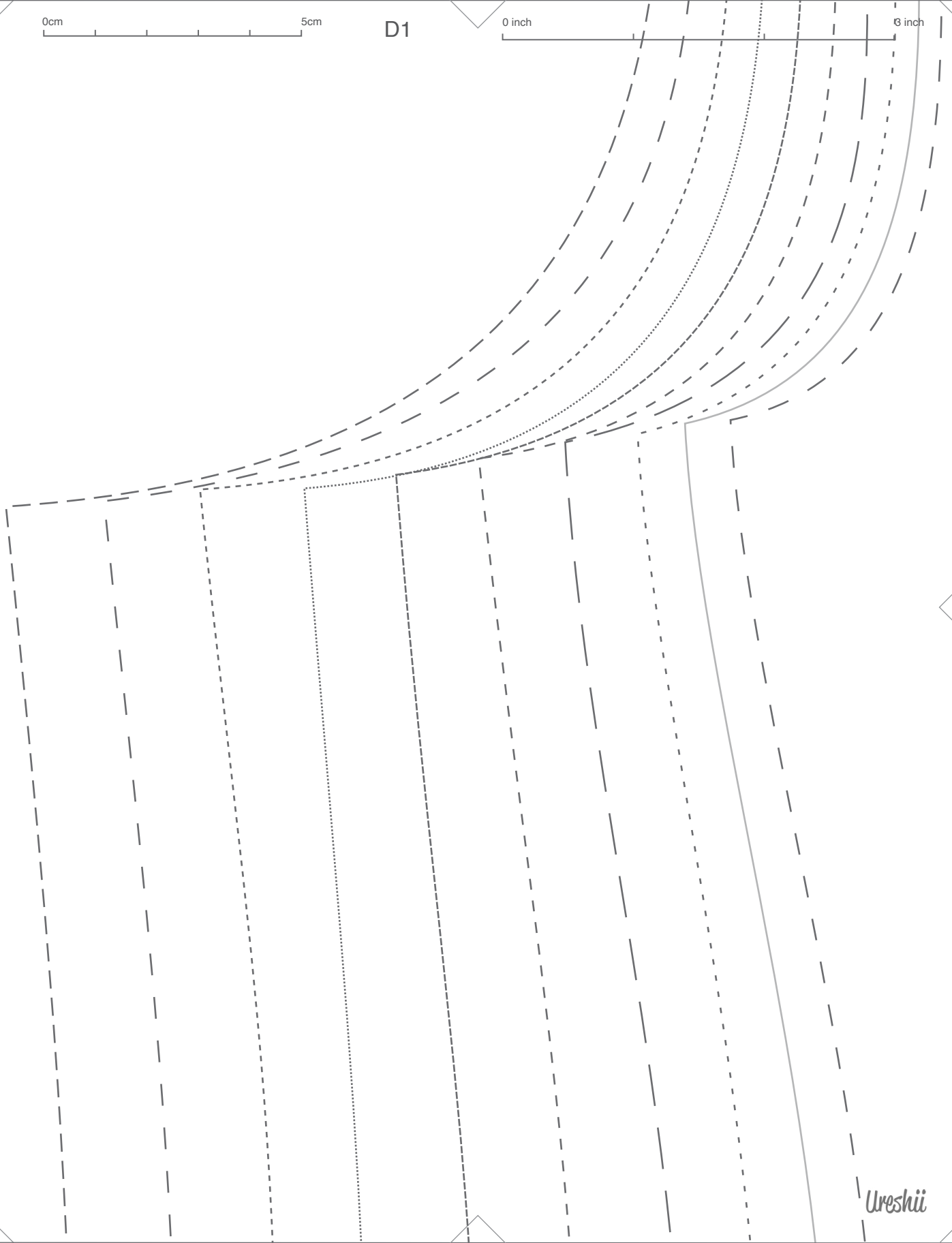

0cm 5cm

D2

0 inch

3 inch

Binder Pattern

Front Overlay

Chest size: all sizes

Cut 1 in jersey fabric

more info @ <https://linktr.ee/freebinderpattern>
or <https://ureshiidesign.ca/blog/binder-free-sewing-pattern-download/>

Ureshii



0cm 5cm

0 inch 3 inch

D3

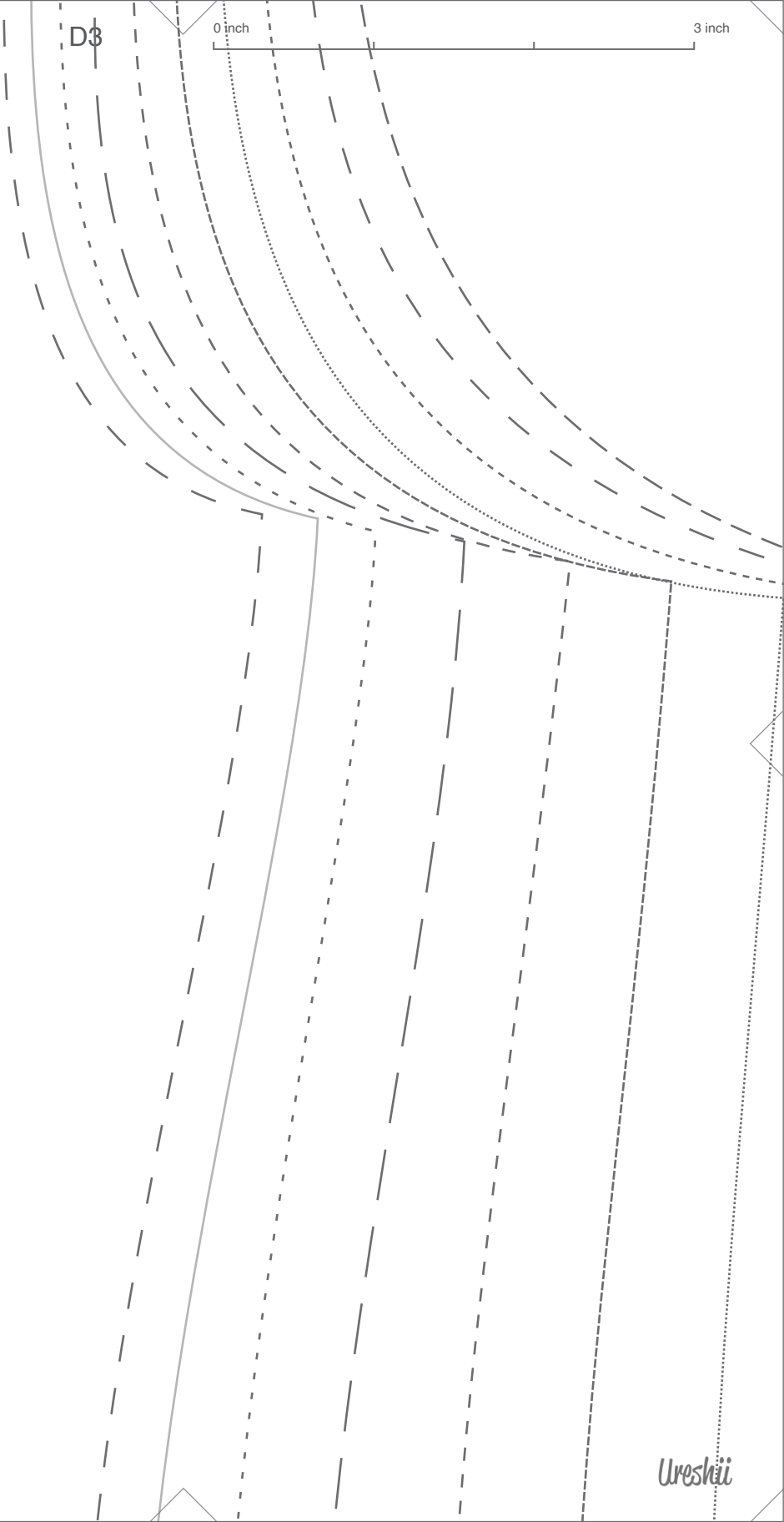

0cm

5cm

D4

0 inch

3 inch

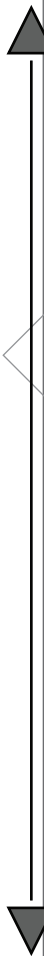
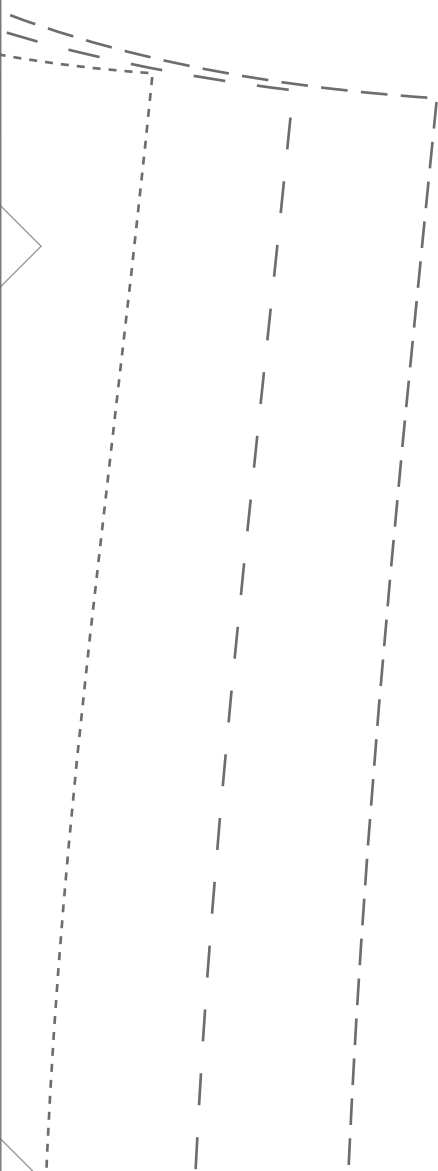

Ureshii

0cm

5cm

D5

0 inch

3 inch

Cut 1 in jersey fabric Cut 1 in mesh fabric

more info @ <https://linktr.ee/freebinderpattern>
or <https://ureshiidesign.ca/blog/binder-free-sewing-pattern-download/>



Ureshii Design

<https://ureshiidesign.ca>

Direction of greatest stretch

0cm

5cm

D6

0 inch

3 inch

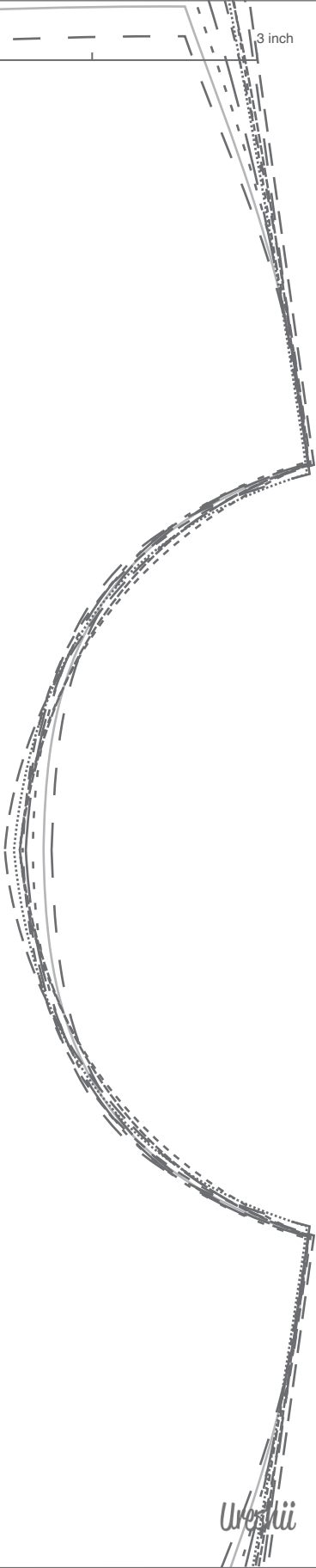

Binder Pattern

Back Underlay

Chest size: all sizes

0cm 5cm

E1

0 inch 3 inch

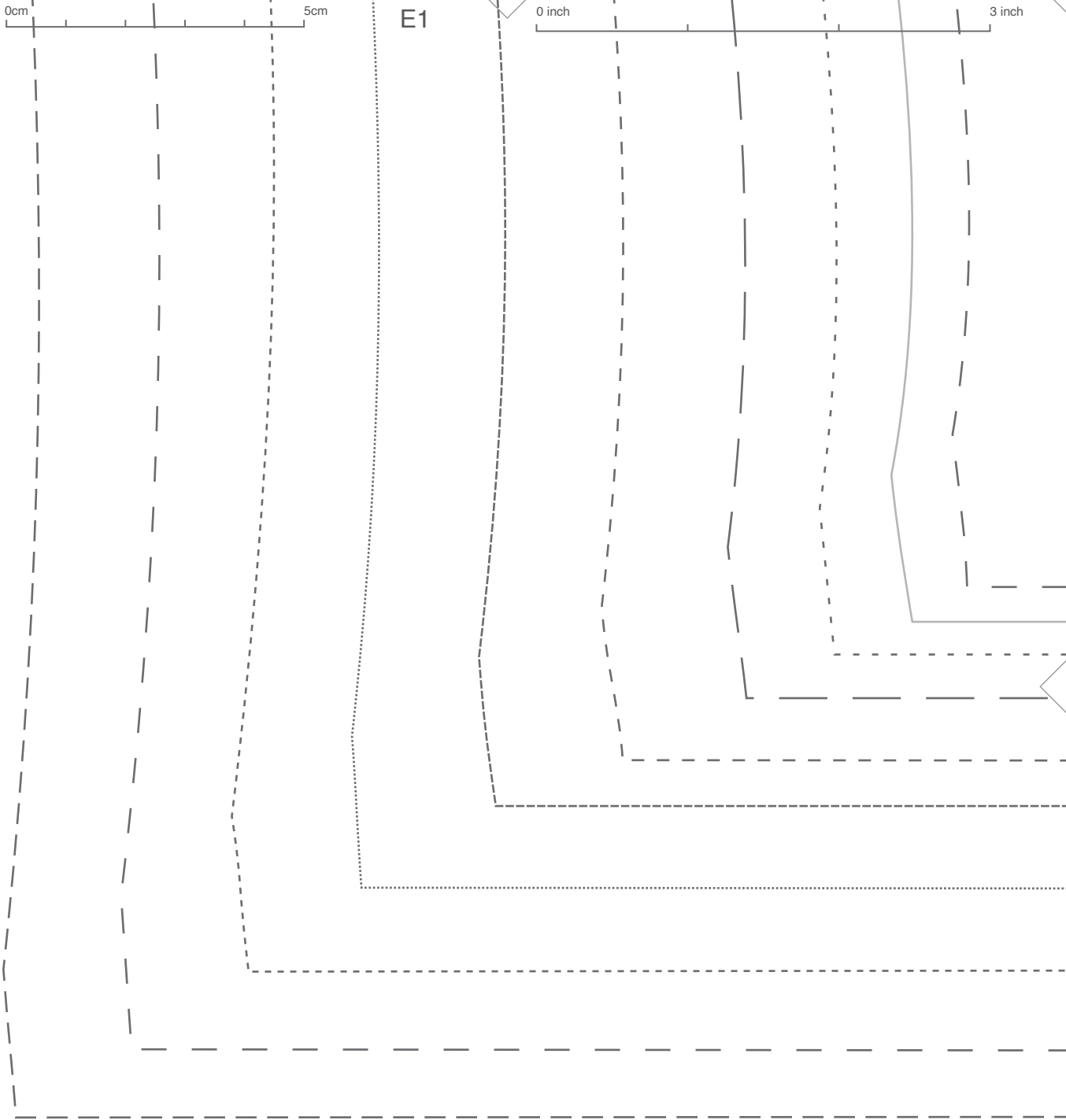

0cm 5cm

E2

0 in

3 inch



Ureshii Design
<https://ureshiidesign.ca>

Direction of greatest stretch



0cm 5cm

E\$

0 inch 3 inch

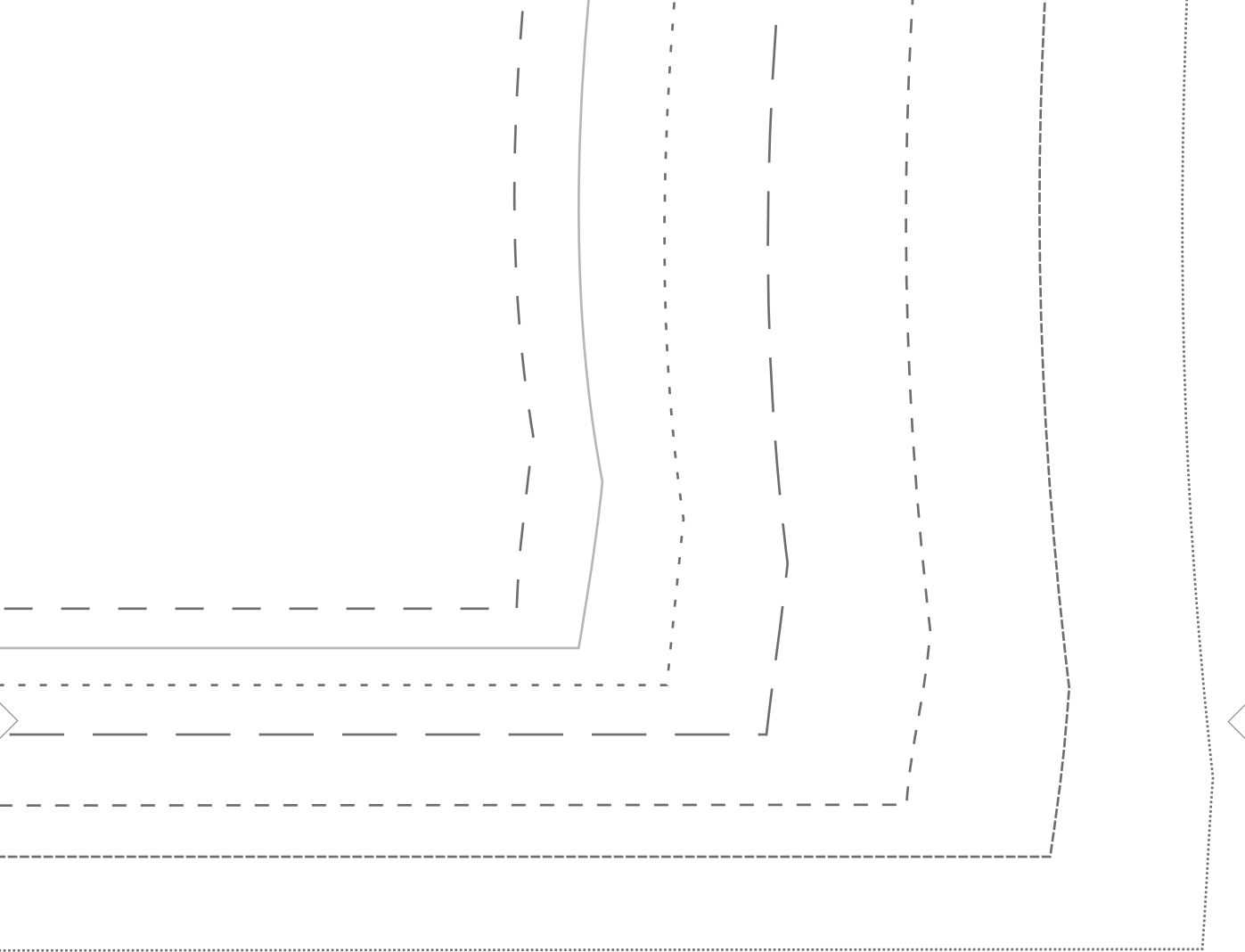

Ureshii

0cm

5cm

E4

0 inch

3 inch

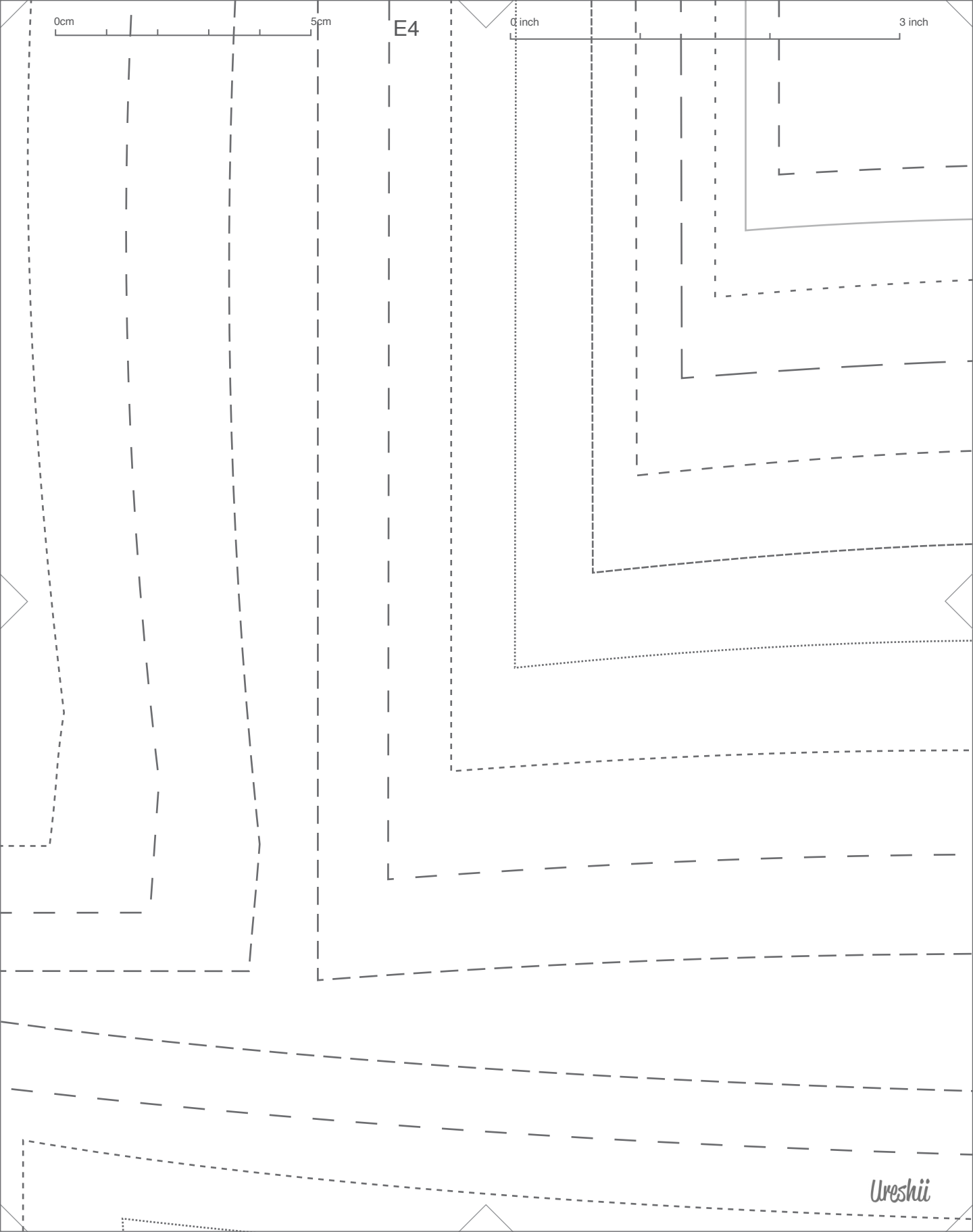

0cm

5cm

E5

0 inch

3 inch

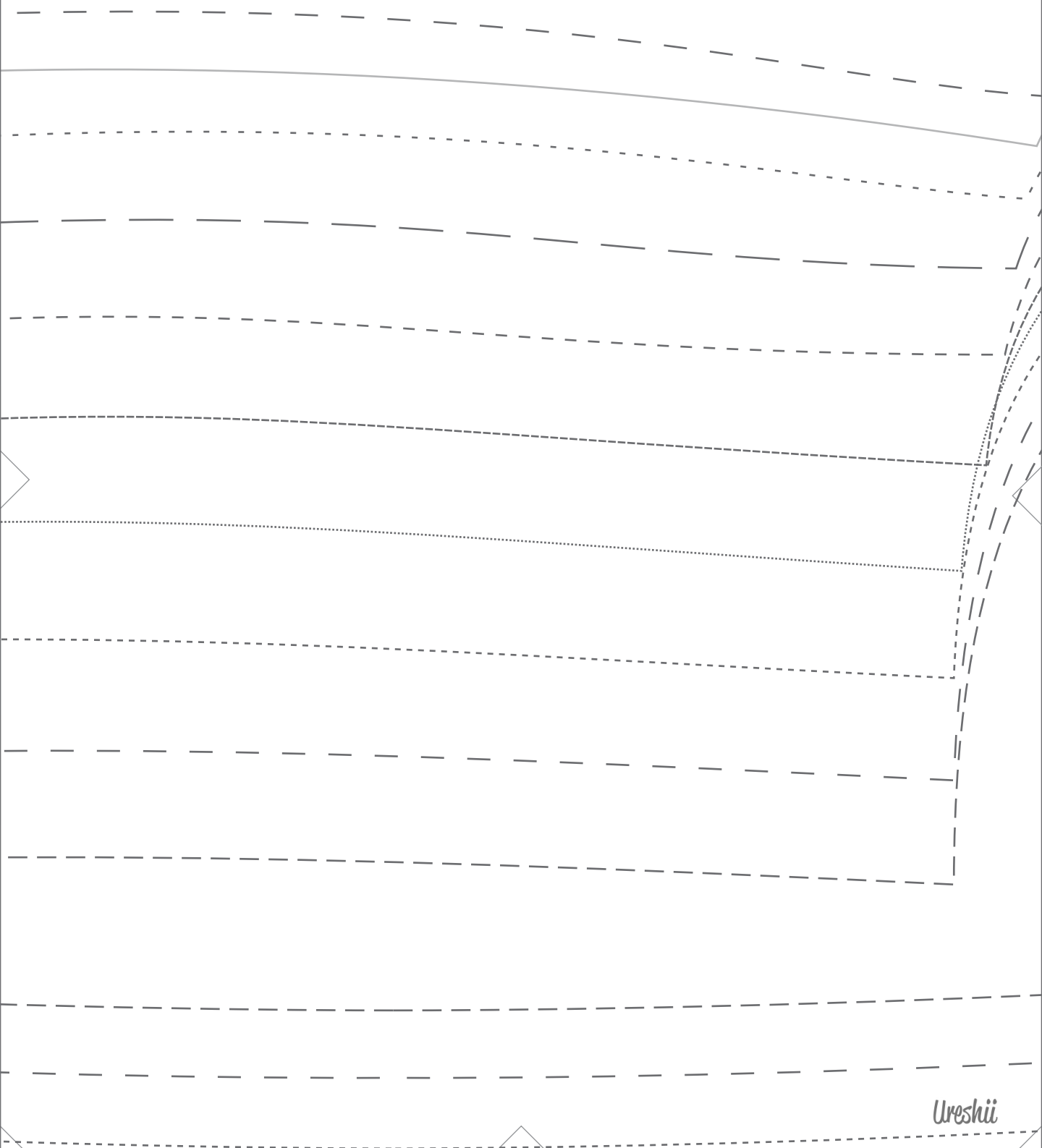

Ureshii

0cm 5cm

E6

0 inch 3 inch

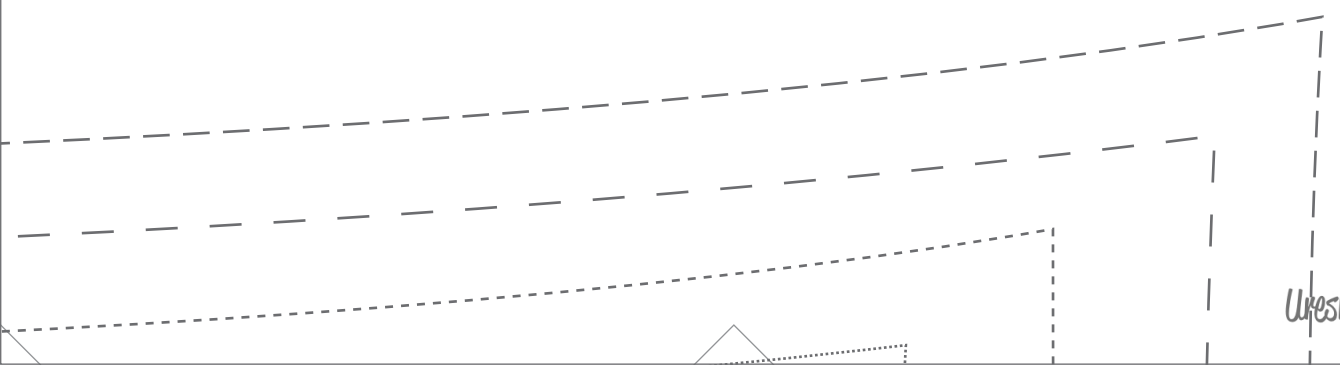
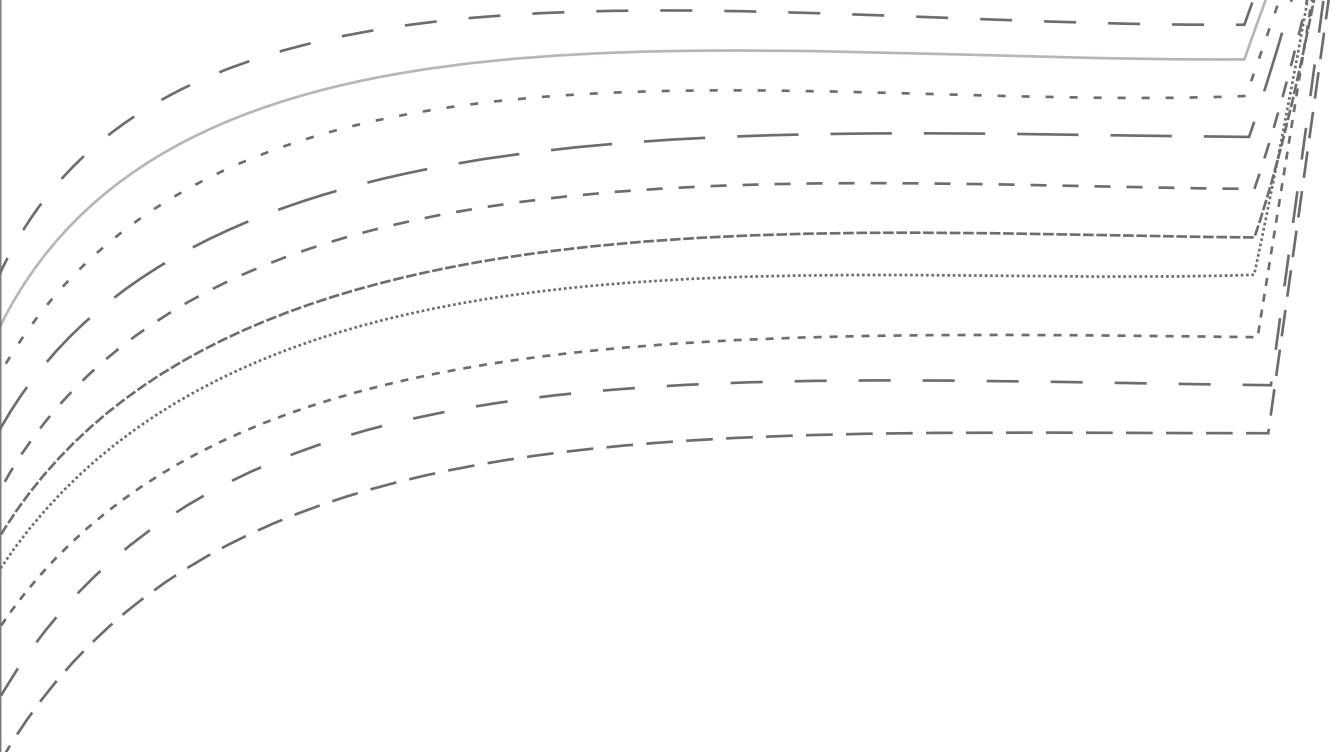

0cm

5cm

F1

0 inch

3 inch

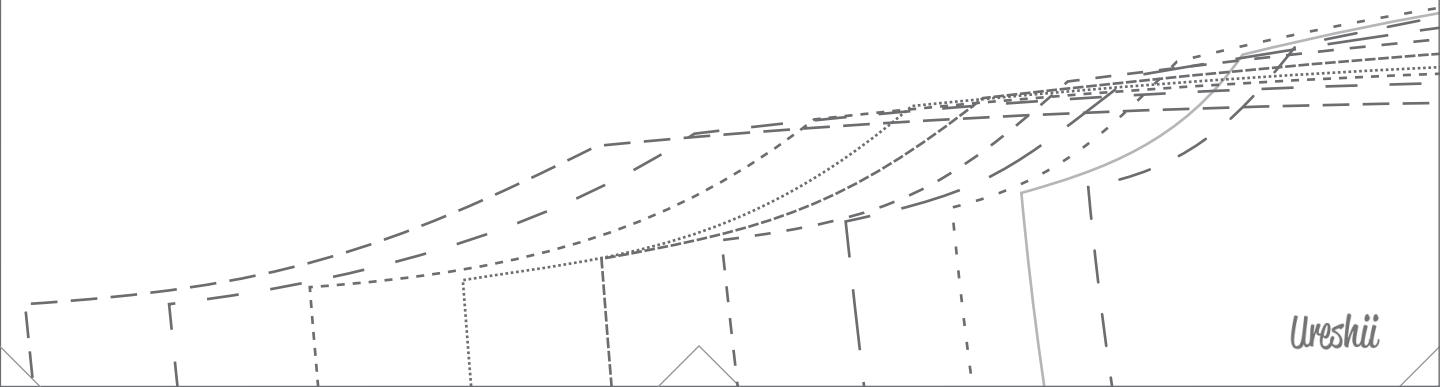

Ureshii

0cm 5cm

F2

0 inch 3 inch

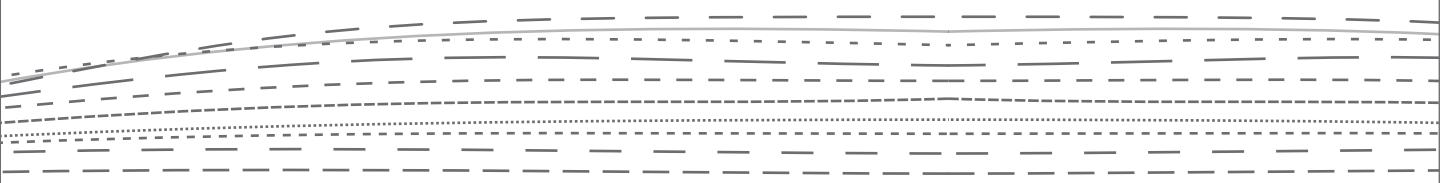

rn
oad/

Ureshii

0cm 5cm

F3

0 inch 3 inch

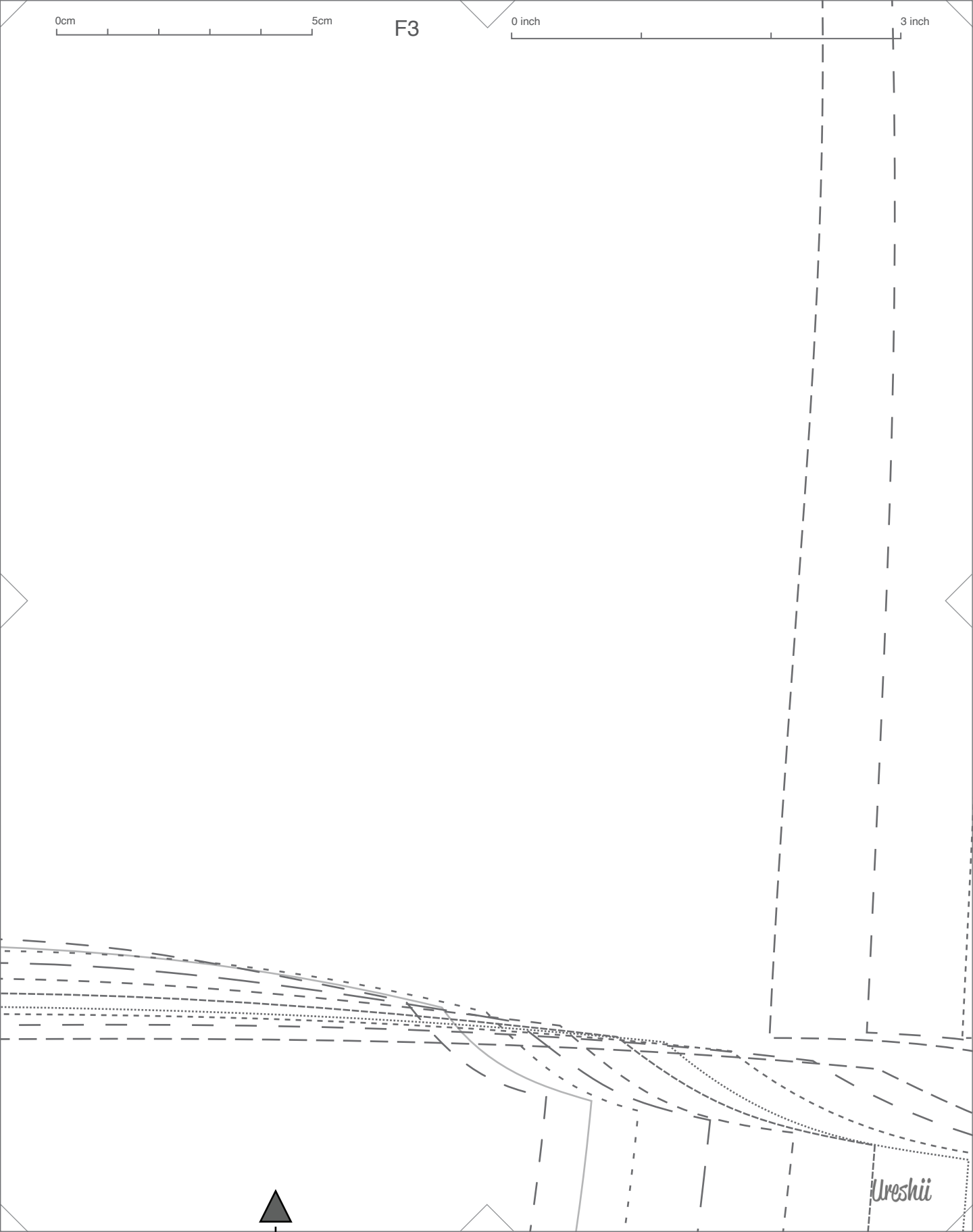

Ureshii

0cm

5cm

F4

0 inch

3 inch

Direction of greatest stretch

Ureshii

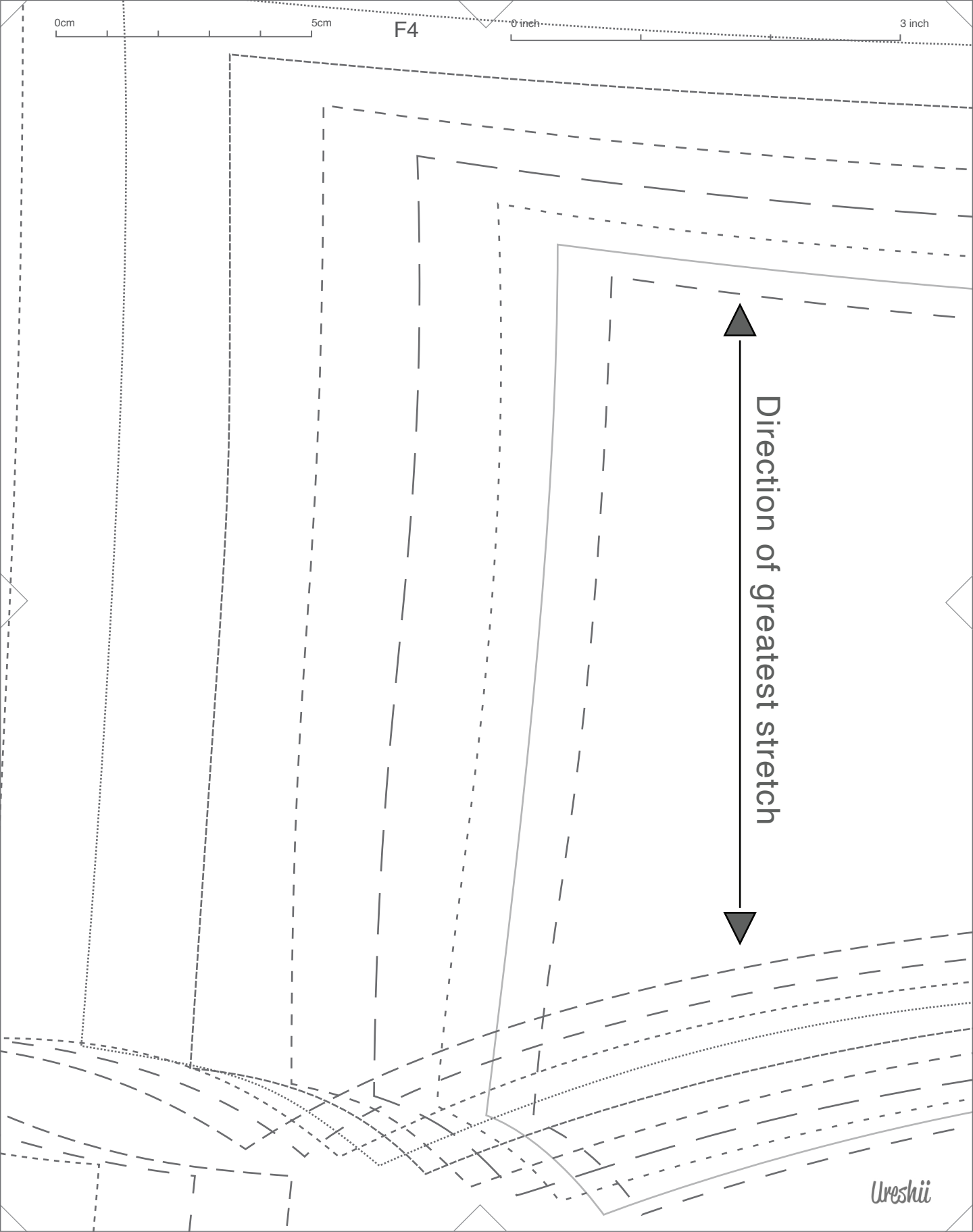

0cm

5cm

F5

0 inch

3 inch

Binder Pattern

Back Stable layer

Chest size: all sizes

Cut 1 in mesh fabric

more info @ <https://linktr.ee/freebinderpattern>

or <https://ureshiiidesign.ca/blog/binder-free-sewing-pattern-download/>



Ureshii Design

<https://ureshiiidesign.ca>

Ureshii

0cm

5cm

F6

0 inch

3 inch

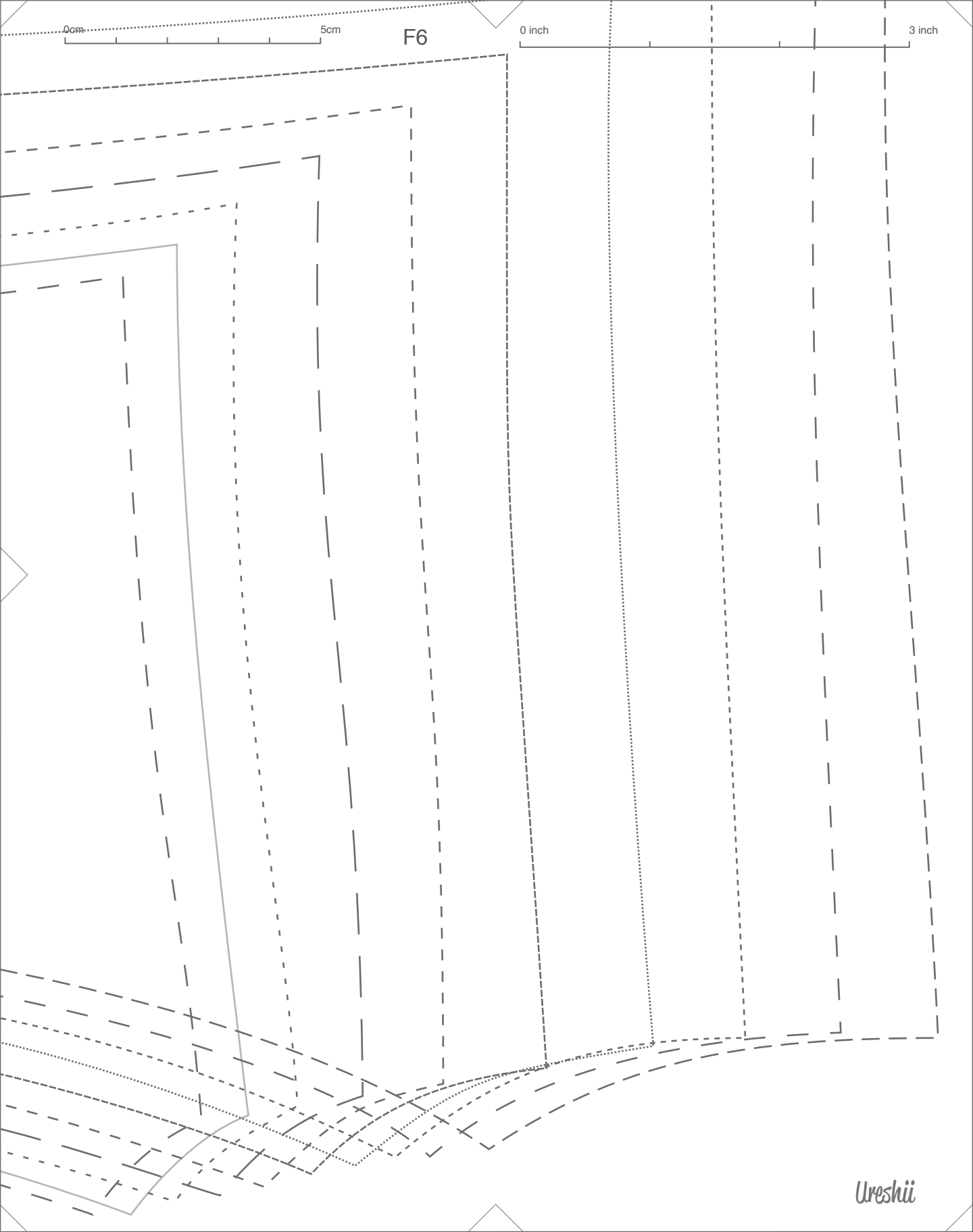

0cm

5cm

G1

0 inch

3 inch

Binder Pattern

Front Stable layer

Chest size: all sizes

G2

Cut 1 in mesh fabric

more info @ <https://linktr.ee/freebinderpatte>
or <https://ureshiidesign.ca/blog/binder/free-sewing-pattern-down>



0cm 5cm

G3

0 inch

3 inch

Direction of greatest stretch

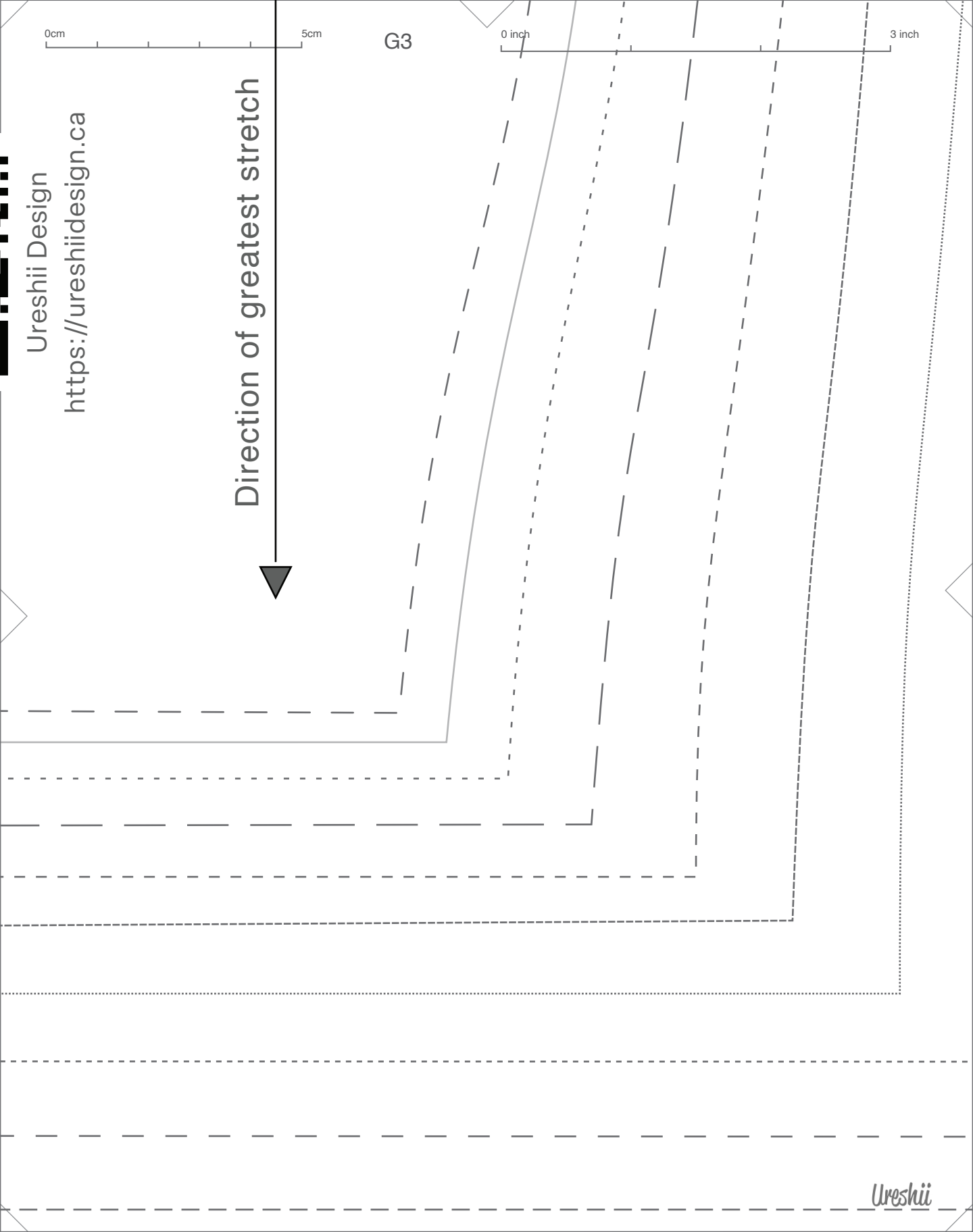

0cm 5cm

G4

0 inch

3 inch

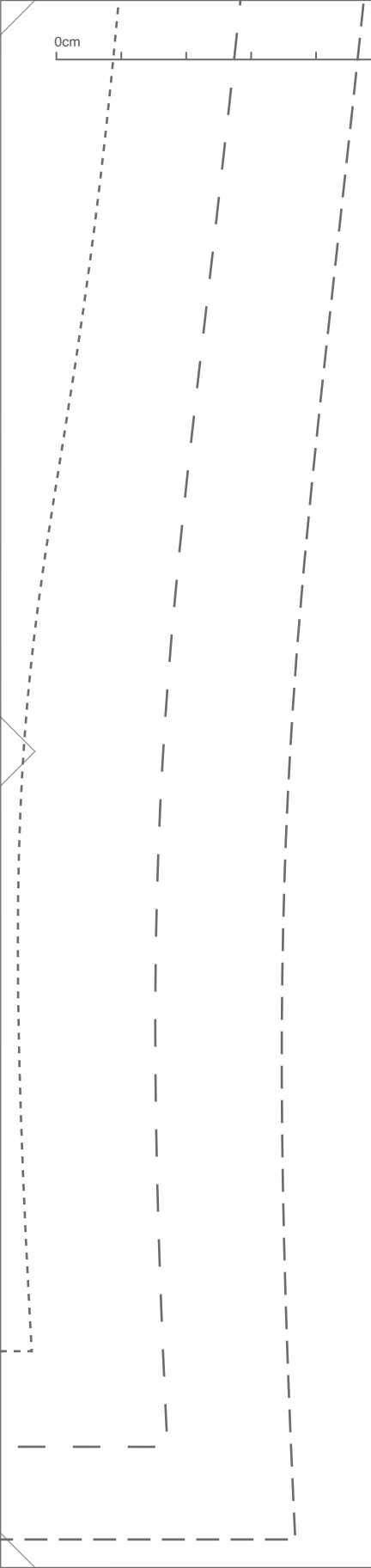

Stroke	Chest Measurement
— — — —	~ 32" or 81cm
————	~ 35" or 89cm
- - - - -	~ 38" or 95cm
—— — — —	~ 41" or 104cm
- - - - -	~ 44" or 112cm
- - - - -	~ 48" or 122cm
.....	~ 51" or 130cm
- - - - -	~ 54" or 137cm
— — — —	~ 57" or 145cm
- - - - -	~ 60" or 152cm

0cm 5cm

G5

0 inch 3 inch

0cm 5cm

G6

0 inch 3 inch